

Severe Duty (SD) Control Valves



Copes-Vulcan has been providing control valves and desuperheaters for the power, process and nuclear industries since 1903. SPX provides a wide range of valves for the control of pressure, temperature and flow-induced noise in all types of power plants. Products include severe service and general service control valves, variable orifice desuperheaters, Raven™, trim and steam-conditioning valves and nuclear control valves, as well as custom designed specialty valves. Copes-Vulcan is recognized worldwide as a leader in valves for severe and critical service applications. Our strength lies in our ability to provide innovative valve solutions for our customers' application needs.

Finding innovative ways to help the world meet its ever growing demand for power is a key focus for SPX. SPX provides creative solutions that serve global energy markets in a myriad of ways. Our ideas are helping build more efficient power plants and renovate older existing facilities. SPX supplies a wide range of components - from air preheaters to filter systems for nuclear, coal-fired, combined cycle, solar, thermal and geothermal power plants.

With operations in over 35 countries, SPX has the global experience and regional presence, products and powerful ideas it takes to help our customers compete more effectively, and more efficiently deliver power to almost any part of the world.

SD Severe Duty Control Valves

The SD-Severe Duty valve is SPX's premium severe duty and critical service control valve design. The SD-Severe Duty line is the next generation of control valves designed specifically for severe duty applications. It is the preferred style of valve for applications such as pump recirculation, feedwater control and feedwater start-up, flashing or cavitating service, critical pressure drop gas and steam service, and any potentially noisy or vibration-prone service. It is also widely used for nuclear "N" stamp and seismic applications.

The SD-Severe Duty line incorporates a number of improvements such as:

- Quick disconnect between valve stem and actuator yoke on most models that greatly simplifies service and inspection.
- An extensive array of standard trims is available including many previously offered only as custom designs.
- Shorter lead times/quicker delivery of both entire valve assemblies and replacement parts.

Improvements such as these, coupled with SPX's innovative yet sound engineering practices, and a reputation for building the best control valves possible, assures that the SD-Severe Duty line is destined to become the new industry standard for severe duty and critical service applications.

For applications requiring pressure classes of 600 and below refer to Copes-Vulcan's GS Series valves.

DESCRIPTION AND PRINCIPLE OF OPERATION

SD-Severe Duty control valve assemblies feature a straight through globe and angle style body design with single web internal construction. The valve body is designed with high structural integrity, large interior flow passageways and a large capacity bowl to accommodate an extensive variety of trim designs while allowing maximum recovery within the valve. The massive amount of body and bonnet material utilized and the thick cross sectional areas allow the SD valve to withstand the most severe operational conditions.

The valve is available in sizes .75–20" (20–500mm) and ASME pressure classes 150 through 4500 standard. Larger sizes are available as required. Typically of cast construction, all standard castable materials are available. When necessary, due to customer preference or technical requirements, forgings are utilized for both body and bonnet. Depending upon size and pressure class, ends are available as threaded, flanged or welded.

The most important sub-assembly of a control valve is the trim. It must control the fluid process, often under extremely high pressure drop conditions, without undue damage due to flashing, cavitation, wire drawing, noise vibration or instability.

SD Series valves can be fitted with an extensive array of standard and high performance trims to meet most severe duty/critical service requirements. Copes-Vulcan specialty trims such as Raven™, Hush™, Soft-Seated Hush, Tandem and GAD™ are readily available to meet the most severe applications. Additionally, custom engineered trims are supplied by SPX as required. All trims are of quick change design to assure ease of maintenance. Most are fully interchangeable between like sizes to ensure maximum flexibility and reduced inventory requirements.

The SD-style design is in accordance with ASME B16.1, B16.5, B16.11, B16.25, B16.34 and, when required, will comply with standards such as CAN Z299.2, .3 and .4, ASME SEC.I, ASME SEC.III, B31.1, PED-"CE", 'N' & 'NPT', 97/23/EC-PED-CE and is also ISO-9001 certified.



Typical product applications

Feedwater Control



Condensate to Deaerator

Superheater Spray Control



Aux. Steam to Deaerator

Reheater Tank Drain to Condenser



Deaerator Water Level Main Control

Boiler Water Tank to Condensor



Drum Level Control

Sootblower PRV

Continuous Blowdown

**Boiler Feedpump
Min Flow Recirculation**



**HP Feedwater Start-Up
Level Control Valve**

RAVEN™ TRIM

Raven trim incorporates a unique advanced design that is superb at limiting flowing velocities to low levels resulting in valves providing service that is quiet, non-cavitating and non-erosive.

Raven's low velocities are achieved through the use of trim cage made by bonding together a series of individual discs. Each disc has a pattern of carefully controlled orifices and channels with a multitude of sharp turns etched into its surface. As the trim's plug travels within the cage the fluid is throttled and forced to travel an extremely torturous path with each turn effecting a stage of pressure drop.

The combined effect of numerous narrow flow channels, each with many sharp turns and a continually expanding flow path, removes kinetic energy from the fluid while gradually lowering its pressure. In doing so, abrupt velocity increases that are the source of noise are avoided. The additional benefit for liquid flow is the elimination of cavitation and the damage it can do to a valve, its trim and the downstream piping.

By its very design Raven trim allows for many more stages of drop than conventional torturous path trims.

Superior to other velocity control trims, Raven, through the use of a consistent narrow wall design, typically is more efficient at passing flow or allowing more turns or stages of drop in a given valve size.

Most Raven trims contain multiple relief points in the flow path as a standard feature. These relief points allow entrained debris to clear the main fluid flow, or in the case of significant path blockage, they provide an effective bypass route for the fluid. With the benefits of the relief points, the actual fluid flow streams still remain virtually separate or discrete from each other for best velocity control.



ACTUAL GASEOUS FLOW THROUGH RAVEN TRIM.

By manufacturing the flow channels to extremely close tolerances, Raven's calculated or predicted versus actual pressure drops are significantly more accurate than competitors. Hence, velocities are more uniform throughout the entire trim, further guarding against noise, erosion and cavitation.

Ultimately, each Raven trim is specifically designed to provide the finest severe duty valve service by Reducing and Attenuating Velocity, Erosion and Noise.



Proven Superior Technology

Note the highly visible attachment phenomenon wherein the flow stream hugs or clings to each obstruction in its path, effectively taking the path of least resistance. Also, despite multiple relief points in the flow path it can be clearly seen that the fluid does not recombine with the Raven trim, rather the flow streams remain virtually separate or discrete from each other for best velocity control.

HUSH® TRIM

HUSH® Trim is an advanced concept in control valve trim for high pressure-drop liquid, gas and steam applications.

It is a cage guided type trim that provides excellent control for compressible and noncompressible fluid applications by directing the flow through a series of staged pressure drops. This unique trim eliminates cavitation in liquid flow and provides multiple pressure breakdown for noise attenuation in critical pressure drop compressible fluid applications.

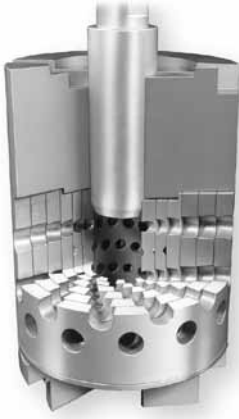

EXCLUSIVE SOFT SEATED HUSH™ TRIM

Soft Seated HUSH Trim is designed for new or replacement trim in Copes-Vulcan valves as well as valves of other manufacturers. Any liquid control valve taking a pressure drop up to 5000 psi (34450 kPa) that spends more than 90% of the time in the closed position must use Soft Seated HUSH Trim to maintain zero leakage. Refer to Bulletin 142 for detailed information.

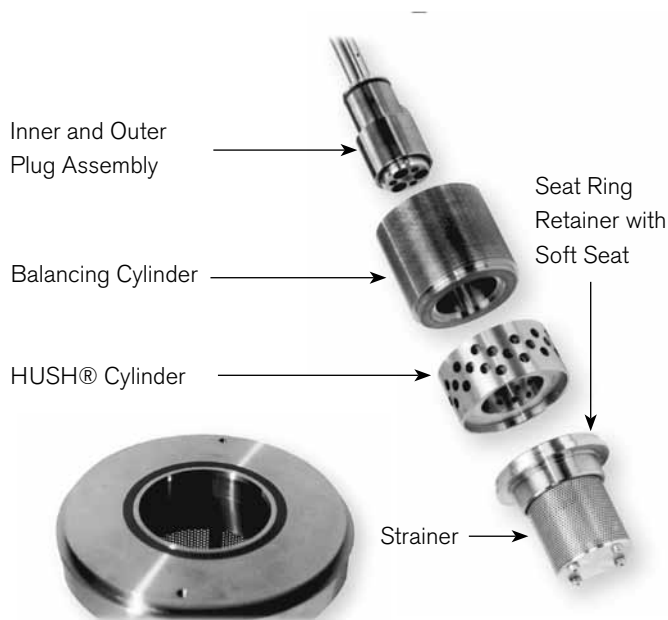

GAD™ TRIM

The Port Throttling GAD trim was developed to meet the rigorous requirements of feedwater startup control. Designed to give optimum flexibility in power operated control valves, the trim is available in double seat, balanced single seat, and tandem versions.

The GAD trim is equally suitable for use with steam and many other fluids. It has been successfully used on high pressure water applications involving pressure of up to 5075 psi (34970 kPa) and pressure differential of up to 3625 psi (24980 kPa).





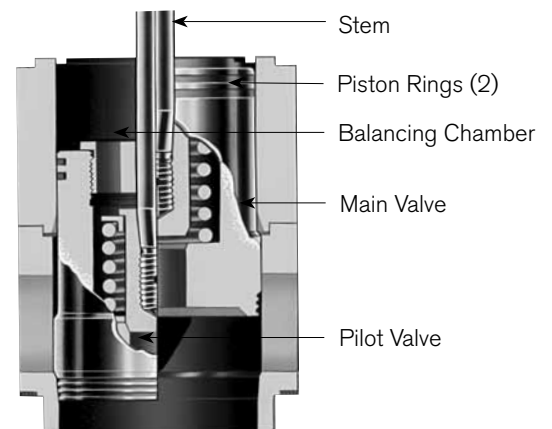

TANDEM TRIM

The Tandem Trim is designed primarily for high pressure differential applications where tight shutoff is essential. Such applications include steam and water pressure reduction, steam throttling to atmosphere or to a condenser, isolation, supercritical boiler startup and a variety of other uses in steam and water control systems. Refer to Bulletin 109 for detailed information.

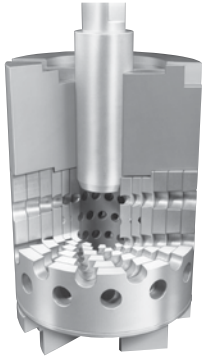

Trim Types

A wide variety of trims is available for SD-Severe Duty Control Valves. They are designed to match virtually any severe duty/critical service operational requirement. All SD trims feature a quick-change design to reduce downtime for inspection, maintenance or change out, and most are cage guided, further ensuring smooth, accurate operation. The majority of the trim line is interchangeable between like sizes, and many reduced trims are also available as standard.

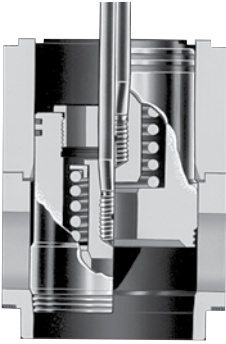
TRIM TYPES	RAVEN	HUSH™ TRIM	SOFT SEATED HUSH™ TRIM	TANDEM TRIM
				
DESCRIPTION/ APPLICATION	Raven is Copes-Vulcan's top-of-the-line high performance specialty trim that offers a proven solution for those severe service applications where a true velocity control trim is the best or possibly the only answer. By limiting the fluid velocities inside the valve, Raven's stacked disc design precludes problems typically associated with high velocity such as erosion, noise, vibration and poor control. Every Raven trim is custom designed to meet the needs of the toughest liquid, steam and gas services in the power and process industries.	HUSH Trim (multiple stage) is a high performance specialty trim that is cage guided and provides excellent control for both compressible and noncompressible fluid applications. By directing the flow through a series of staged pressure drops, this unique trim eliminates cavitation in liquid flow and provides multiple pressure breakdown for noise attenuation in critical pressure drop compressible fluid application. It is designed for all valve sizes.	Soft seated Hush Trim (double plug) is a high performance specialty trim that is cage guided and designed to provide and maintain extremely tight shutoff for high pressure differential liquid applications. Typically applied to operating conditions that exhibit pressure drops in excess of 1800 psig (12400 kPag) that are to remain closed more than 25% of the time. It is the ideal trim for applications such as boiler feed pump recirculation, spray block valves and spray control valves.	Tandem Trim is a high performance specialty trim that is a cage guided, uniquely balanced port throttling trim designed to solve difficult high temperature, high pressure differential applications that would require oversized, expensive actuators if more standard trims were utilized. Due to the relatively small pilot plug designed into the tandem trim, tight shutoff of up to Class V can easily be achieved with a moderately sized, economically priced actuator. It is available for valves 4" (100mm) and larger.
STANDARD FCI 70-2/ANSI RATED SEAT LEAKAGE	Class IV standard Class V optional *Class VI optional	Class IV standard Class V optional *Class VI optional	Class VI standard	Class IV standard Class V optional
STANDARD TRIM CHARACTERISTIC	Linear standard, Specials optional	Linear standard, Specials optional	Linear standard, Specials optional	Special
TYPICAL FLOW DIRECTION	Under the seat Over the seat	Under the seat	Over the seat	Over the seat Under the seat
MAXIMUM RANGEABILITY	200:1 Or greater as required	35-50:1	Under the seat	25-50:1

* Class VI requires use of soft seat.

The trims shown in this bulletin represent the more common selections available. Additional standard, special and custom engineered trims can be supplied as required.

Standard stocked trim materials are 300 series and 400 series stainless steel. Other materials are available on special order.

GAD TRIM	UNBALANCED SINGLE SEAT PLUG THROTTLING	UNBALANCED SINGLE SEAT PORT THROTTLING	BALANCED SINGLE SEAT PORT THROTTLING	BALANCED SINGLE SEAT PORT THROTTLING (HI-TEMP)
				
<p>GAD Trim is a high performance specialty trim that is cage guided and engineered to meet the rigorous requirements of feedwater control and feedwater startup control. Designed to give optimum flexibility in automated control valves, this trim is available in double seat, balanced single seat, tandem plug and one-stage Hush versions. GAD Trim is equally suitable for use with steam and many other fluids. It has been successfully used on high pressure water applications involving pressure of 5075 psi (34970 kPa) and pressure differential of up to 3625 psi (24980 kPa). It is available for valves 2" (50mm) and larger.</p>	<p>This trim style is a general purpose cage guided trim for on/off or modulating control. It is designed for low to moderate pressure drop applications. The solid plug has a contour on its lower end that provides varying flow area with lift, thus regulating the flow. It can be used with a wide variety of non-abrasive/non-adhesive compressible and noncompressible fluids. Standard trim for valve sizes 1.5" (40mm) and smaller.</p>	<p>This trim style is a general service cage guided trim for on/off or modulating control where moderate flow rates exist along with low differential pressures. The unbalanced single seat plug modulates flow by uncovering ports in the cage. The cage porting produces the pressure drop or flow control. This trim can be used in most non-abrasive/non-adhesive compressible and noncompressible fluids.</p>	<p>This trim style is a general purpose cage guided trim for on/off or modulating control suitable for use in most non-abrasive/non-adhesive compressible and noncompressible fluid services. The balanced plug design reduces actuator force requirements thus permitting the use of smaller, less expensive actuators while maintaining tight shutoff capability. It is designed for valves 2" (50mm) and larger and is a standard offering when the service temperature does not exceed the 400°–500°F (204°– 260°C) range, relative to pressure.</p>	<p>This general purpose cage guided trim is virtually identical in all respects to the balanced single seat port throttling trim except that piston rings are used in lieu of the elastomeric seal on the trim's plug. While the piston rings do limit the leakage rate to ANSI Class III, this trim is a viable option when a balanced plug is desirable and when temperatures of the fluid exceed 500°F (260°C). It is for valve sizes 2" (50mm) and larger.</p>
<p>Class III–IV Depending upon design selected</p>	<p>Class IV standard Class V optional</p>	<p>Class IV standard Class V optional</p>	<p>Class IV standard Class V optional *Class VI optional</p>	<p>CClass IV standard</p>
<p>Modified parabolic, linear, equal percentage. All available as standard</p>	<p>Modified parabolic, linear, equal percentage.</p>	<p>Modified parabolic, linear, equal percentage</p>	<p>Modified parabolic, linear, equal percentage</p>	<p>Modified parabolic, linear, equal percentage</p>
<p>Over the seat</p>	<p>Under the seat</p>	<p>Under the seat</p>	<p>Over the seat</p>	<p>Over the seat</p>
<p>50:1</p>	<p>50:1</p>	<p>35-50:1</p>	<p>35-50:1</p>	<p>35-50:1</p>

* Class VI requires use of soft seat.

Trim Types (Cont.)

TRIM TYPES	ONE STAGE HUSH	CASCADE	CAV B9®	TOP GUIDED
				
DESCRIPTION/ APPLICATION	<p>One Stage Hush trim is a specialty trim designed to reduce noise associated with compressible fluids as well as to reduce the undesirable effects of flashing and cavitation that would occur with most single pressure drop trims. The Hush cage consists of a single cylinder with a large number of radially drilled orifices. The fluid exits the orifices as low energy jets resulting in significant reductions in noise or erosion. Although numerous standard designs are available, One Stage Hush is often custom engineered to provide various flow characteristics or optimal performance under specific operating conditions.</p>	<p>This trim style is a cage guided plug throttling trim designed primarily for high pressure drop water applications where cavitation, vibration and excessive wear occur with conventional trims. The tapered plug fits into a cage and seat with a matching taper, thus small changes in flow area occur with respect to plug travel resulting in extremely high rangeability. The labyrinth grooves machined into the plug's taper create a series of orifices which reduces the total pressure drop in a series of stages. It is especially suited to applications where small flow rates must be controlled accurately.</p>	<p>CAV B9 trim can be applied in liquid service where low level cavitation is evident. By utilizing flow over the seat, the radially step-drilled cage design reduces the effects of cavitation along with the associated noise and erosion problems by forcing the cavitation to occur in the center of the cage, away from all metal surfaces. In instances where flashing conditions are experienced, flow under the seat is employed with the multitude of small ports reducing both noise and erosion. Although numerous standard designs are available, the trim can be custom designed to provide various flow characteristics or optimal performance under specific flow conditions. It is available for valves 2" (50mm) and larger.</p>	<p>This non-cage guided trim is designed for use with a wide variety of process applications involving corrosive, erosive and viscous line fluids and many steam and water applications. It is ideal for control applications where a maximum of free flow area is desired. The trim is unbalanced, single seat, plug throttling with the plug guided by a large diameter metal or teflon insert along the lower stem area. This guiding method ensures quiet, stable, vibration free operation with pressure drops limited to 600 psi (4130 kPa) under operating conditions. Pressure drop should also be limited to avoid cavitation or flashing. It is for valve sizes 4" (100mm) and smaller.</p>
STANDARD FCI 70-2/ANSI RATED SEAT LEAKAGE	Class IV standard Class V optional *Class VI optional	Class IV standard Class V optional	Class IV standard Class V optional *Class VI optional	Class IV standard Class V optional *Class VI optional
STANDARD TRIM CHARACTERISTIC	Linear standard Specials optional	Special	Linear standard Specials optional	Equal percentage, linear
TYPICAL FLOW DIRECTION	Under the seat Over the seat	Under the seat	Under the seat (for flashing) Over the seat (for cavitation)	Under the seat
MAXIMUM RANGEability	35-100:1	200:1	35-100:1	25:1

* Class VI requires use of soft seat.

Actuators

MODEL 1000 ACTUATORS PNEUMATIC DIAPHRAGM – SPRING OPPOSED

Designed specifically for severe duty service, model 1000 actuators can be used in any application where shock and/or vibration are anticipated, or where seismic analysis is required. They are available with 60, 100, 160 260 and 400 in² (390, 645, 1030, 1680 and 2580 cm²) of effective diaphragm area in both the direct and reverse acting mode. All models are available with manually operated override wheels.

To illustrate how the actuator transmits force, the shaded areas shown in the diagrams below will move during the direct and reverse acting modes. (Note the position of the diaphragm plate in each case.)

Conversion of the actuator from direct to reverse acting is accomplished simply by unfastening the diaphragm base from the frame and rotating it 90° until it is positioned above the threaded holes in the yoke. The actuator can be returned to the direct acting mode by reversing the procedure. Stem changes may be required.

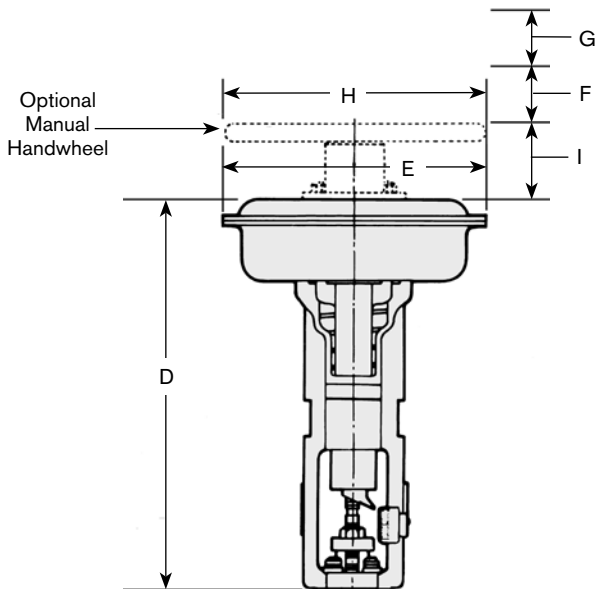

Model 1000 Actuators Dimensions

ACTUATOR MODEL	D	E	F*	G**	H	I
1000-60	<u>17.25</u> 438	<u>11.50</u> 292	<u>1.50</u> 38	<u>8.50</u> 216	<u>10.00</u> 254	<u>7.75</u> 197
1000-100	<u>25.56</u> 649	<u>15.12</u> 383	<u>3.50</u> 89	<u>11.25</u> 286	<u>18.00</u> 457	<u>7.75</u> 197
1000-160	<u>30.88</u> 784	<u>18.00</u> 457	<u>3.50</u> 89	<u>11.25</u> 286	<u>18.00</u> 457	<u>7.75</u> 197
1000-400	<u>47.25</u> 1200	<u>27.50</u> 698	<u>4.50</u> 114	<u>13.00</u> 330	<u>20.00</u> 508	<u>20.75</u> 527

*Clearance required for reverse action

** Clearance required for actuator removal

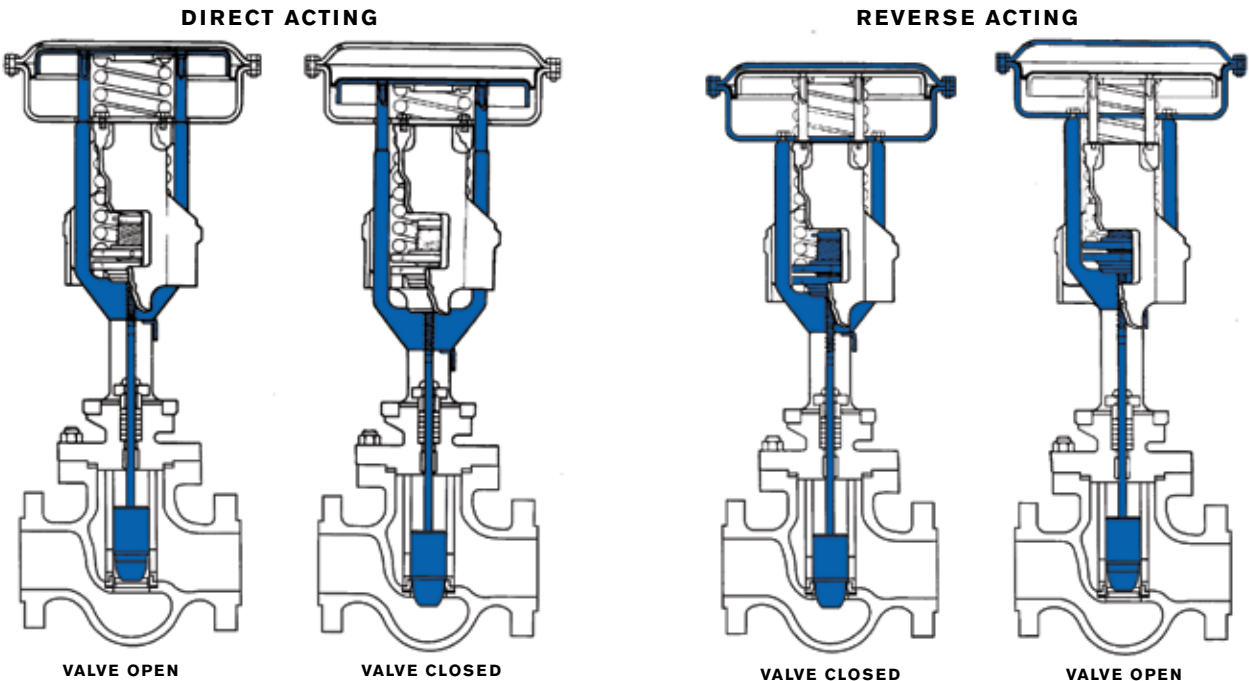

Actuators

THE SD-700 VALVE ASSEMBLY

The SD-700 valve assembly is comprised of an SD valve body, bonnet and trim with the 700 series actuator. In those instances where an SD valve (i.e. body, bonnet, trim, etc.) is necessary, but the use of the heavy duty, 1000 style actuator is not needed, the more economical 700 style operator can be utilized.

Series 700 actuators are pneumatic diaphragm operators that have spring return in both direct and reverse acting styles, offering fail-open and fail-closed modes respectively. The pressed steel diaphragm case construction along with the nylon reinforced Buna N rubber diaphragm permits a maximum allowable air supply pressure of 80 psig (550 kPag). This pre-formed diaphragm provides a constant effective area throughout the full extent of travel. With effective diaphragm areas ranging from 60–160 in² (385–1030 cm²), Series 700 actuators can provide the necessary stem force to meet many operating requirements.

SERIES 700 ACTUATOR (SHOWN WITH OPTIONAL TOP-MOUNTED HANDWHEEL)

Reverse Acting (Spring-to-Close)

ACTUATOR SIZE	60	100	160	160L
L	21.09 536	28.06 713	32.38 822	40.81 1037
M	11.50 292	15.12 384	18.00 457	18.00 457
N*	6.50 165	6.50 165	6.25 159	6.38 162
O	6.72 171	11.38 289	11.56 294	17.19 437
P	10.00 254	18.00 457	18.00 457	18.00 457

Inches
millimeters

*Distance to actuator stem connection

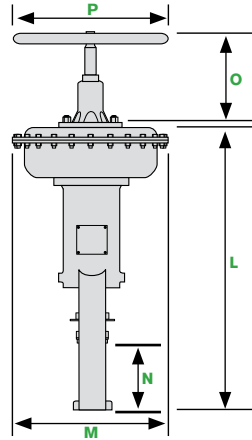

Direct Acting (Spring-to-Open)

ACTUATOR SIZE	60	100	160	160L
L	20.50 521	28.12 714	32.31 821	39.75 1010
M	11.50 292	15.12 384	18.00 457	18.00 457
N*	7.56 192	9.38 238	9.31 236	11.81 300
O	5.81 148	9.44 240	9.50 241	15.19 386
P	10.00 254	18.00 457	18.00 457	18.00 457

Inches
millimeters



MODEL 1000-260 ACTUATOR

This actuator provides 260 in² (1680cm²) of effective diaphragm area and is offered with either direct or reverse action. As a variation of the 1000 style, the 1000-260 actuator has a number of features.

- Heavy duty, one-piece frame
- Large assortment of springs to cover a wide range of applications
- High thrust and long travel capability
- Optional handwheel activated hydraulic override units

MODEL 200 PISTON ACTUATORS

When necessitated by travel or thrust requirements, model 200 pneumatic actuators are supplied. Contact Copes-Vulcan for details.

SERIES 300 MOTOR OPERATED

Motor operated actuators are available to meet specified operations. Contact Copes-Vulcan for details.

SIDE MOUNTED HANDWHEEL

Side mounted handwheels are available for the Series 700 actuator. Contact Copes-Vulcan for details and dimensions.



SERIES 800 MANUAL OPERATED ACTUATORS

Copes-Vulcan offers handwheel operated actuators for applications where an automated valve is not required or where compressed air service is unavailable. Series 800 actuators are suitable for both on/off and modulating service.

ACCESSORIES

Typical valve-mounted accessories such as positioners, air filter regulators, solenoids, and limit switches are available as standard offerings.

Dimensions

SD Valve Body/Bonnet Assembly

FLANGED ENDS

VALVE SIZE	CLASS 150			CLASS 300			CLASS 400			CLASS 600			CLASS 900			CLASS 1500			CLASS 2500		
	A	B	C	A	B	C	A	B	C	A	B	C	A	B	C	A	B	C	A	B	C
.75" 20mm	7.25 184	7.00 178	2.56 65	7.62 194	7.00 178	2.56 65	8.12 206	7.00 178	2.56 65	8.12 206	7.00 178	2.56 65	11.12 282	10.00 254	2.50 64	11.12 282	10.00 254	2.50 64	12.12 308	10.00 254	2.50 64
1" 25mm	7.25 184	7.00 182	2.56 65	7.75 197	7.00 178	2.56 65	8.25 210	7.00 178	2.56 65	8.25 210	7.00 178	2.56 65	11.50 292	10.00 254	2.75 70	11.50 292	10.00 254	2.75 70	12.50 318	10.00 254	2.75 70
1.5" 40mm	8.75 222	7.55 184	2.88 73	9.25 235	7.25 184	2.88 73	9.88 251	7.25 184	2.88 73	9.88 251	7.15 182	2.88 73	13.12 333	10.15 258	3.00 76	13.12 333	10.15 258	3.00 76	14.12 359	10.15 258	3.25 83
2" 50mm	10.00 254	7.34 186	3.50 89	10.50 267	7.34 186	3.50 89	11.25 286	7.34 186	3.50 89	11.25 286	7.34 186	3.50 89	14.75 375	10.15 258	3.75 95	14.75 375	10.15 258	3.75 95	15.75 400	10.15 258	3.88 99
2.5" 60mm	10.88 276	9.31 236	4.06 103	11.50 292	9.31 236	4.06 103	12.25 311	9.31 236	4.19 106	12.25 311	9.31 236	4.19 106	16.12 409	12.15 309	4.44 113	16.12 409	12.15 309	4.44 113	17.38 441	12.15 309	4.62 117
3" 75mm	11.75 298	9.72 247	4.44 113	12.50 318	9.72 247	4.44 113	13.25 337	9.72 247	4.50 114	13.25 337	9.72 247	4.50 114	17.38 441	12.47 317	4.56 116	17.38 441	12.47 317	4.81 122	19.62 498	12.47 317	5.56 141
4" 100mm	13.88 353	9.91 252	5.38 137	14.50 368	9.91 252	5.38 137	15.25 387	9.91 252	5.56 141	15.50 394	9.91 252	5.56 141	20.62 524	13.56 344	6.12 155	21.38 543	13.56 344	6.12 155	23.12 587	13.56 344	6.50 165
6" 150mm	17.75 451	12.16 309	7.69 195	18.62 473	12.16 309	7.69 195	19.50 495	12.16 309	7.88 200	20.00 508	12.16 309	7.88 200	23.62 600	14.81 376	8.12 206	27.25 692	14.81 376	8.94 227	32.25 819	14.81 376	9.44 240
8" 200mm	21.38 543	13.31 338	10.25 260	22.38 568	13.31 338	10.25 260	23.38 594	13.31 338	10.56 268	24.00 610	13.31 338	10.56 268	30.75 781	16.06 408	10.82 275	33.00 838	16.06 408	11.25 286	40.50 1029	16.06 408	11.94 303
10" 250mm	29.38 746	19.00 482	13.00 330	30.75 781	19.00 482	13.00 330	31.75 806	19.00 482	13.00 330	32.50 826	19.00 482	13.00 330	34.00 864	22.06 560	13.00 342	42.00 1067	22.06 560	14.00 356	54.00 1372	22.06 560	14.88 378
12" 300mm	35.25 895	23.06 586	15.00 381	36.75 933	23.06 586	15.00 381	37.75 959	23.06 586	15.19 386	38.50 978	23.06 586	15.10 386	40.00 1016	26.06 662	15.56 395	48.00 1219	26.06 662	15.31 389	62.00 1575	26.06 662	16.38 416

Inches
millimeters

FLANGED ENDS

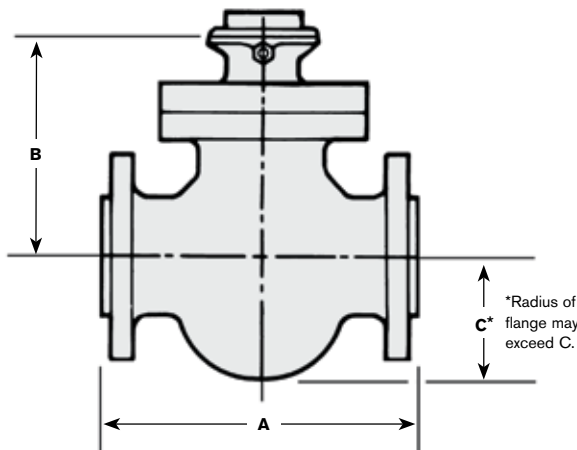

WELD ENDS AND THREADED ENDS

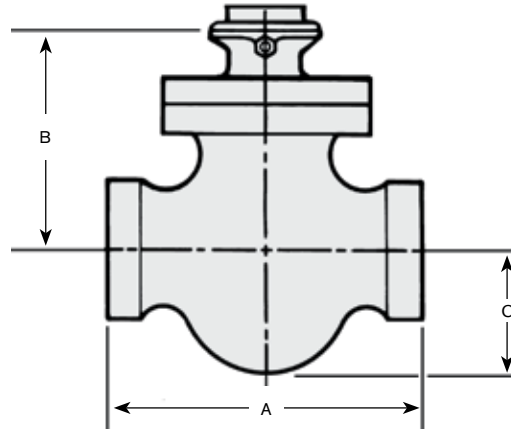

Note: The SD-style bonnet is easily adaptable to all sizes and types of pneumatic, electric and hydraulic actuators.

WELD ENDS AND THREADED ENDS (FOR 2" (50MM) AND SMALLER)

VALVE SIZE	CLASS 150			CLASS 300			CLASS 400			CLASS 600			CLASS 900			CLASS 1500			CLASS 2500		
	A	B	C	A	B	C	A	B	C	A	B	C	A	B	C	A	B	C	A	B	C
.75" 20mm	7.75 197	7.00 178	2.56 65	7.75 197	7.00 178	2.56 65	7.75 197	7.00 178	2.56 65	7.75 197	7.00 178	2.56 65	7.75 197	10.00 254	2.50 64	7.75 197	10.00 254	2.50 64	8.50 216	10.00 254	2.50 64
1" 25mm	7.75 197	7.00 178	2.56 65	7.75 197	7.00 178	2.56 65	7.75 197	7.00 178	2.56 65	7.75 197	7.00 178	2.56 65	7.75 197	10.00 254	2.75 70	7.75 197	10.00 254	2.75 70	8.50 216	10.00 254	2.75 70
1.5" 40mm	9.25 235	7.25 184	2.88 73	9.25 235	7.25 184	2.88 73	9.25 235	7.25 184	2.88 73	9.25 235	7.25 184	2.88 73	9.25 235	10.15 258	3.00 76	9.25 235	10.15 258	3.00 76	10.25 260	10.15 258	3.25 83
2" 50mm	10.50 267	7.34 186	3.50 89	10.50 267	7.34 186	3.50 89	10.50 267	7.34 186	3.56 90	10.50 267	7.34 186	3.56 90	11.50 292	10.15 258	3.75 95	11.50 292	10.15 258	3.75 95	12.50 318	10.15 258	3.88 99
2.5" 60mm	11.50 292	9.31 236	4.06 103	11.50 292	9.31 236	4.06 103	11.50 292	9.31 236	4.19 106	11.50 292	9.31 236	4.19 106	11.50 292	12.15 309	4.44 113	11.50 292	12.15 309	4.44 113	12.50 318	12.15 309	4.62 117
3" 75mm	12.50 318	9.72 247	4.44 113	12.50 318	9.72 247	4.44 113	12.50 318	9.72 247	4.50 114	12.50 318	9.72 247	4.50 114	12.50 318	12.47 317	4.56 116	12.50 318	12.47 317	4.81 122	15.00 381	12.47 317	5.56 141
4" 100mm	14.50 368	9.91 252	5.38 137	14.50 368	9.91 252	5.38 137	14.50 368	9.91 252	5.56 141	14.50 368	9.91 252	5.56 141	14.50 368	13.56 344	6.12 155	14.50 368	13.56 344	6.12 155	16.00 406	13.56 344	6.50 165
6" 150mm	20.00 508	12.16 309	7.69 195	20.00 508	12.16 309	7.69 195	20.00 508	12.16 309	7.88 200	20.00 508	12.16 309	7.88 200	20.00 508	14.81 376	8.12 206	22.00 559	14.81 376	8.94 227	24.00 610	14.81 376	9.44 240
8" 200mm	24.00 610	13.31 338	10.25 260	24.00 610	13.31 338	10.25 260	24.00 610	13.31 338	10.56 268	24.00 610	13.31 338	10.56 268	24.00 610	16.06 408	10.82 275	27.00 686	16.06 408	11.25 286	30.00 762	16.06 408	11.94 303
10" 250mm	30.00 762	19.00 482	13.00 330	30.00 762	19.00 482	13.00 330	30.00 762	19.00 482	13.00 330	30.00 762	19.00 482	13.00 330	30.00 762	22.06 560	13.00 342	34.00 864	22.06 560	14.00 356	40.00 1016	22.06 560	14.88 378
12" 300mm	36.00 914	23.06 586	15.00 381	36.00 914	23.06 586	15.00 381	36.00 914	23.06 586	15.19 386	36.00 914	23.06 586	15.19 386	36.00 914	26.06 662	15.56 395	38.00 965	26.06 662	15.31 389	44.00 1118	26.06 662	16.38 416

Inches
millimeters



Global locations

SPX FLOW TECHNOLOGY

5620 West Road
McKean, PA 16426
United States of America
+1 814 476 5800

SPX FLOW TECHNOLOGY

Road Two, Industrial Estate
Winsford, Cheshire CW7 3QL
England
+44 1606 552041

SPX FLOW TECHNOLOGY

25 International Business Park
#03-03/12 German Centre
Singapore 609916
+65 6264 4366

SPX FLOW TECHNOLOGY

6F Treasury Building
1568 Hua Shan Road
Shanghai 200052
PR China
+86 21 2208 5888

Based in Charlotte, North Carolina, SPX Corporation (NYSE: SPW) is a global Fortune 500 multi-industry manufacturing leader. For more information, please visit www.spx.com

SPX FLOW TECHNOLOGY

5620 West Rd.
McKean, PA 16426
P: (814)476-5800
F: (814)476-5854
E: cv@spx.com

SPX reserves the right to incorporate our latest design and material changes without notice or obligation.

Design features, materials of construction and dimensional data, as described in this bulletin, are provided for your information only and should not be relied upon unless confirmed in writing. Please contact your local sales representative for product availability in your region. For more information visit www.spx.com.

The green ">" is a trademark of SPX Corporation, Inc.

ISSUED 05/2012 CV-1149

COPYRIGHT © 2012 SPX Corporation